









33 805 809



- Ausladung 167 mm
- schwenkbarer Auslauf 360°
- luftangereicherter Strahl
- Durchfluss max. 7 l/min bei 3 bar Fließdruck
- bleifrei
- Dieses Produkt leistet einen Beitrag zur Erfüllung der Vorgaben von nachhaltigen Gebäudezertifizierungen, z.B. LEED®, BREEM®, DGNB

	Chrom	33 805 809-00
	Platin gebürstet	33 805 809-06
	Platin	33 805 809-08
	Messing (23kt Gold)	33 805 809-09
	Dark Chrome	33 805 809-19
	Messing gebürstet (23kt Gold)	33 805 809-28
	Schwarz matt	33 805 809-33
	Champagne gebürstet (22kt Gold)	33 805 809-46
	Champagne (22kt Gold)	33 805 809-47
	Chrom gebürstet (Edelstahl-Look)	33 805 809-93
	Dark Platinum gebürstet	33 805 809-99

Empfohlenes Zubehör

VAIA Spender mit Rosette - Chrom 82 434 809-00



33 805 809

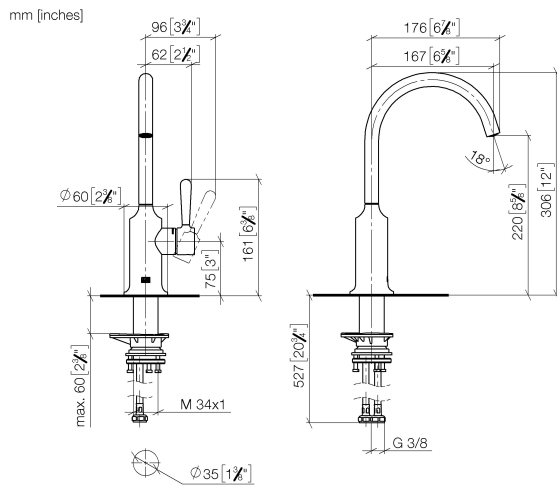

Durchflussdiagramm



Zertifikate

LGA_29299.

33 805 809

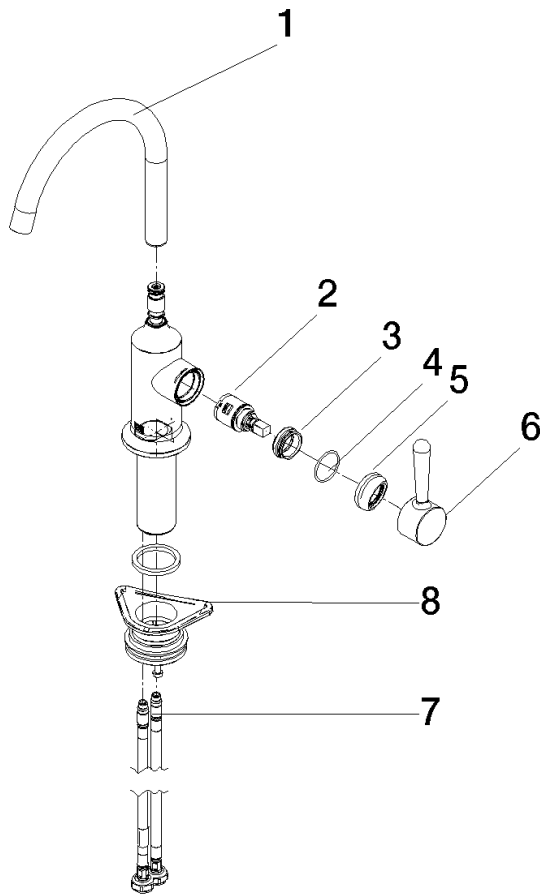

Ersatzteilstückliste

Nr.	Artikelnummer	Benennung	Verbaumenge	Lieferzeit
1	90 28 22 311 02-00	Auslauf	1	10
2	90 15 05 042 00 90	Kartusche	1	2
3	09 24 04 266 90	Mutter	1	2
4	09 14 10 091 90	Dichtung	1	2
5	90 28 30 052 00-00	Haube	1	10
6	90 20 80 050 00-00	Griff	1	10
7	04 30 04 100 00 90	Schlauch	2	2
8	04 23 10 044 08 90	Befestigungssatz	1	2